

RC-67M

RC-67M has been updated to include more details to be consistent with both ADAAG and PROWAG.

The following slides discuss the general notes found on Sheet 1.

RC-67M Note

Construct curb ramps with a minimum 1220 x 1220 (4'-0" x 4'-0") clear space beyond the curb face, within the width of the crosswalk and wholly outside the parallel vehicle travel lane. See sheet 7 for crosswalk details.

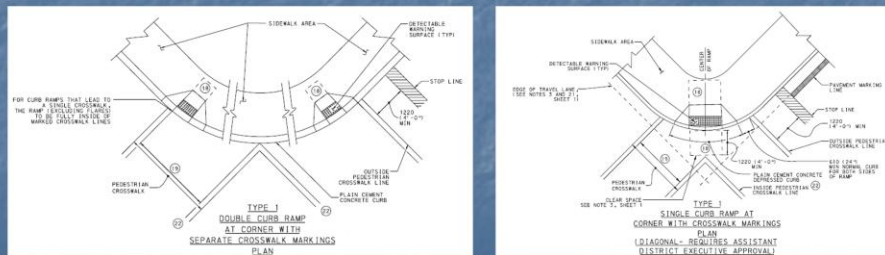

RC-67M note

Construct curb ramps with a minimum 1220 x 1220 (4'-0" x 4'-0") clear space beyond the curb face, within the width of the crosswalk and wholly outside the parallel vehicle travel lane. See sheet 7 for crosswalk details.

The graphic on the left is the preferred installation of one curb ramp to one crossing.

On the right is the diagonal installation, one ramp with 2 crossings, which is not preferred.

RC-67M Note

To avoid chasing grade indefinitely when traversing the height of curb, ramp length not to exceed 4500 (15'-0"). Adjust ramp slope as needed to provide access to the maximum extent feasible.

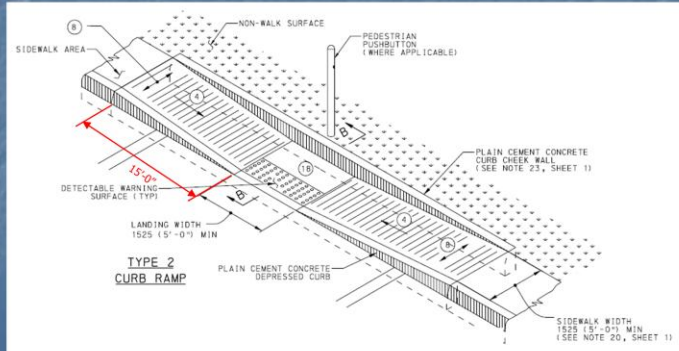

RC-67M

To avoid chasing grade indefinitely when traversing the height of curb, ramp length not to exceed 4500 (15'-0"). Adjust ramp slope as needed to provide access to the maximum extent feasible.

RC-67M Note

Provide detectable warning surfaces (DWS) 610 (24") minimum (in the direction of pedestrian travel) across full width of ramp at the grade break near street edge. Provide DWS that contrast visually with adjacent walkway surfaces, either light-on-dark or dark-on-light for the full width of ramp.



RC-67M Note

Provide detectable warning surfaces (DWS) 610 (24") minimum (in the direction of pedestrian travel) across full width of ramp at the grade break near street edge. Provide DWS that contrast visually with adjacent walkway surfaces, either light-on-dark or dark-on-light for the full width of ramp.

Align detectable warning domes on a square grid in the predominant direction of the ramp and perpendicular to curb.

The detectable warning surface is to provide a **location** cue to a person with disabilities. It is not intended to give a **directional** cue.

RC-67M Note

For new construction and alterations, construct curb ramp and flare slopes with the flattest slope possible. The slopes indicated in the details show the max slope allowable. Slopes that exceed those indicated in the details, or contract documents as applicable, will not be accepted and will be reconstructed.

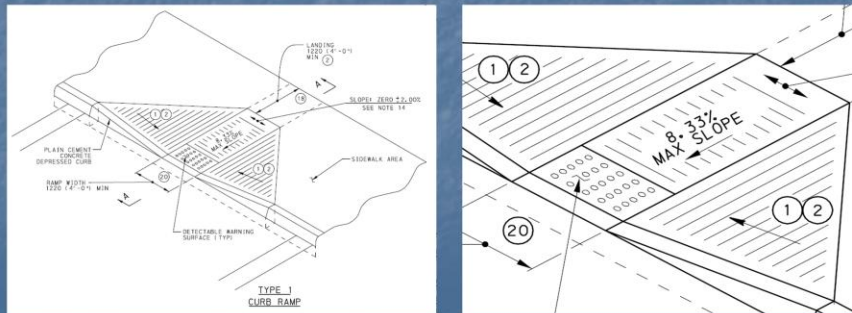

RC-67M Note

For new construction and alterations, construct curb ramp and flare slopes with the flattest slope possible. The slopes indicated in the details show the max slope allowable. Slopes that exceed those indicated in the details, or contract documents as applicable, will not be accepted and will be reconstructed.

The construction tolerance is the maximum slope to any slope flatter. If a form is set to 8.33% and due to a error with concrete pour and finishing, the slope is 8.4%, it will not be accepted and must be reconstructed.

Recommended Slopes vs. Maximum Allowable Slopes

RECOMMENDED SLOPES	MAX ALLOWABLE SLOPES
8.33%	10.00%
7.14%	8.33%
1.00%	2.00%

DESIGN SLOPES

Recommendation:

During design or construction of curb ramps, use recommended slopes to provide additional construction tolerances.



Recommended slopes vs. Max allowable slopes.

Due to the reasons mentioned on previous slide, it is strongly recommended that the recommended slopes are used where applicable to provide additional construction tolerances.

RC-67M Note

The construction standards depicted are most appropriate for new construction. All construction must meet the standards contained herein unless otherwise noted or directed.

RC-67M Note

The construction standards depicted are most appropriate for new construction. All construction must meet the standards contained herein unless otherwise noted or directed.

If a designer can not use a standard ramp type but can provide a design that does not exceed the ramp slopes and can meet the other requirements such as cross slope and landings areas, then this is also acceptable. The designer will be required to provide the detail needed to have the design constructed. On the same topic, for example, if a designer can use a standard curb ramp type but must increase the ramp slope to 9.00% to provide the maximum access possible, these details must also be included in the plan set.

EQUIVALENT SLOPES

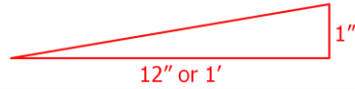

PERCENT SLOPE	EQUIVALENT SLOPE
10.00%	10: 1 (1: 10)
8.33%	12: 1 (1: 12)
7.14%	14: 1 (1: 14)
5.00%	20: 1 (1: 20)
2.00%	50: 1 (1: 50)
1.00%	100: 1 (1: 100)

EQUIVALENT SLOPES



Equivalent slopes.

This slide is included to discuss a useful "rule of thumb".

For a LEVEL site, repeat...for a **level site**, 8" of curb reveal will equate to 8' of ramp length. Again this is only true for a level site. By using this general rule, curb ramp designs can be quickly processed.

RC-67M Note

All slopes are measured with respect to a level plane. Therefore, the length of ramp is not solely dependant on the height of curb. (For example, a 150 (6") curb does not necessarily mean a ramp length of 1830 (6'-0") for a 12:1 (1:12) slope).

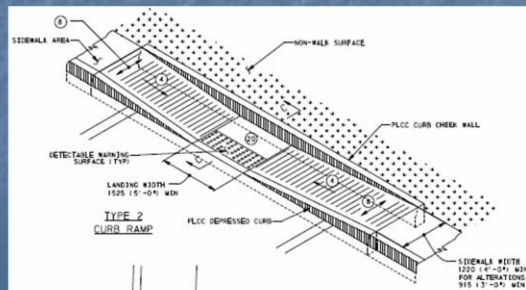

RC-67M Note

All slopes are measured with respect to a level plane. Therefore, the length of ramp is not solely dependant on the height of curb. (For example, a 150 (6") curb does not necessarily mean a ramp length of 1830 (6'-0") for a 12:1 (1:12) slope).

When a digital level is used, it measures with respect to a level plane. So on a site with a significant grade, the rule of thumb mentioned will not give accurate results.

Sidewalk Typical Section

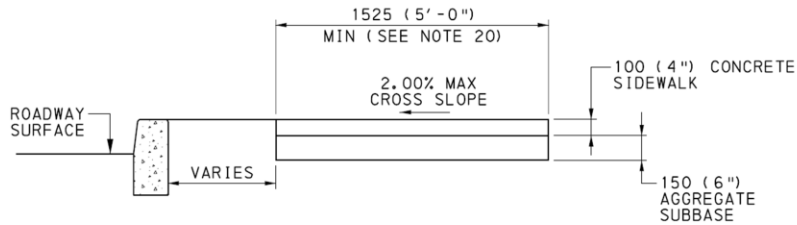

20. SIDEWALK WIDTH MAY BE REDUCED TO 1220 (4'-0"), WHEN PASSING AREAS 1525 X 1525 (5'-0" X 5'-0") ARE PROVIDED EVERY 61 METERS (200').



A Sidewalk typical section has been added to RC-67M.

The minimum sidewalk width is 5'. This width maybe reduced to 4' when passing areas are provided every 200'. Max 2% cross slope is also strictly enforced.

RC-67M Note

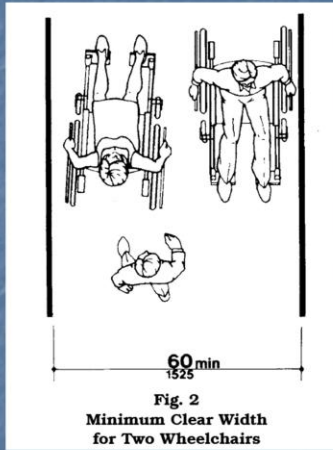

Sidewalk width may be reduced to 1220 (4'-0") when passing areas 1525 x 1525 (5'-0" x 5'-0") are provided every 61 meters (200').

RC-67M Note

Sidewalk widths may be reduced to 1220 (4'-0") when passing areas 1525 x 1525 (5'-0" x 5'-0") are provided every 61 meters (200').

This provides enough space for passing wheelchairs but also side by side pedestrian traffic. It is important to note that the sidewalk width must ultimately be determined by pedestrian volume and need. These are only the minimum widths.

Depressed Curb for Curb Ramps

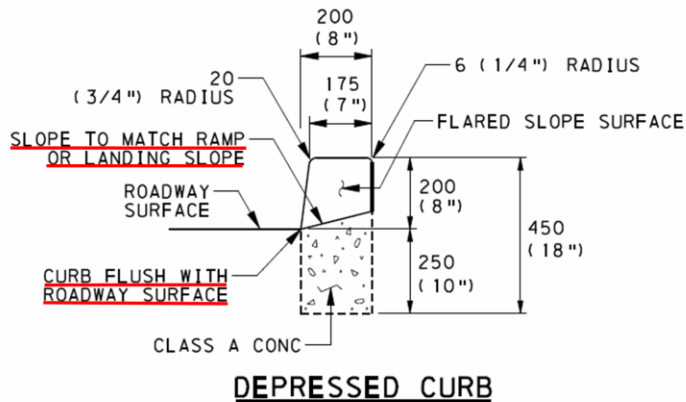

Depressed curb for curb ramps has also been added to RC-67M. The depressed curb must be flush at the curb ramp. The standards are very clear that a 1/4" max lip can be located in the pedestrian path, but at a curb ramp the depressed curb shall be flush. At driveways the depressed curb may have an 1 1/2" lip but not at curb ramps.

The top of the depressed curb at curb ramps may also be sloped to match the adjacent curb ramp or landing. This will help keep drainage at the flow line.

Ramps on Medians

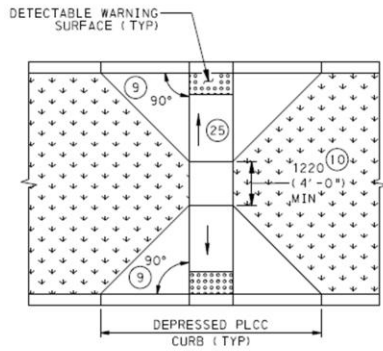

**RAMPED MEDIAN OR ISLAND
ACCESS OPENING
(TYPE I DOUBLE CURB RAMPS)**

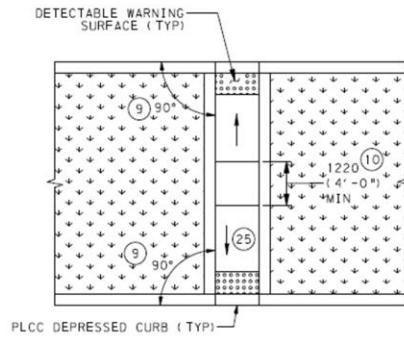

**RAMPED MEDIAN OR ISLAND
ACCESS OPENING
(TYPE A DOUBLE CURB RAMPS)**

9 90° DESIRABLE

10 LANDINGS ARE NOT REQUIRED FOR
RAMP LONGITUDINAL SLOPES 5.00% OR LESS



When a pedestrian path crosses a raised median, curb ramps shall be installed to transition the curb reveal. When curb ramps are placed back to back, a level landing is required to provide a resting area between the curb ramps.

Separate Ramps Preferred

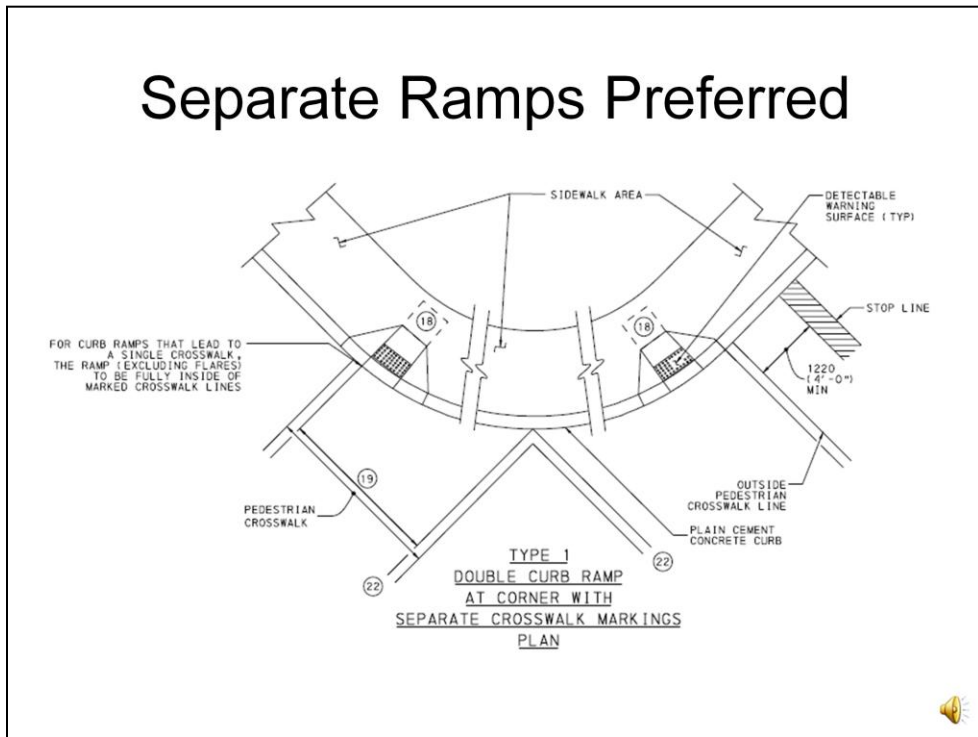

Separate ramps are preferred.

For this slide you can see each crossing has a separate curb ramp. For this type of installation, the depressed curb for the curb ramp must be completely within the markings. The flares may extend beyond the markings as shown on the left curb ramp.

Diagonal Ramps & Crosswalks

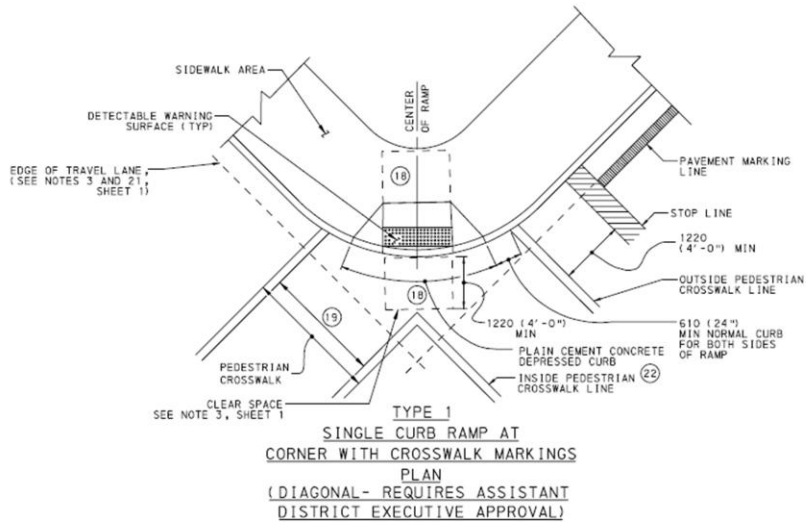

Diagonal ramps are NOT preferred.

For this slide you can see 2 crossings that merge at a single curb ramp. For this type of installation, the curb ramp must be completely within the markings, including the flares as shown.

Diagonal Ramps & Crosswalks

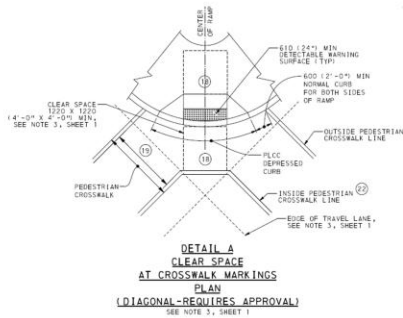

Diagonal curb ramps as mentioned, must provide a 4'x4' clear space completely inside the crosswalk markings and completely outside of the extended travel lanes.

In the picture, the travel lane is directly against the face of curb. This causes a corner of the clear space to project into the travel lane. This should be avoided.

Designers must always consider separate curb ramps rather than a diagonal.



DWS at Railroad Crossings

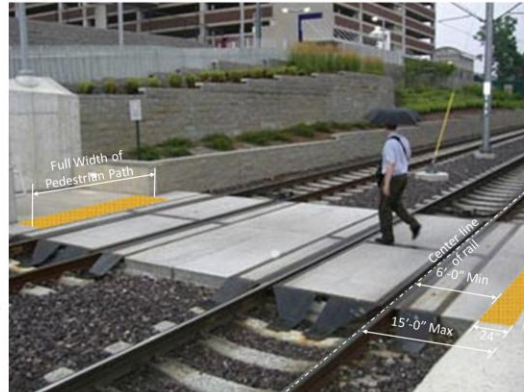
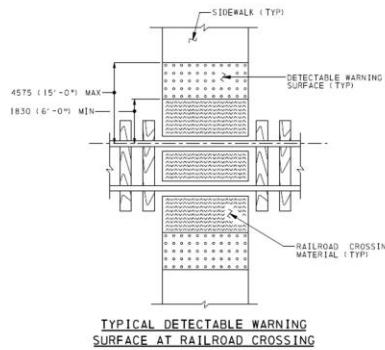

DWS must not only designate travel lanes, but also railroad crossings where the pedestrian paths cross railroads.

In the picture, you can see that a 24" strip is installed the width of the pedestrian path at an offset from the nearest rail.





Pedestrian push buttons must have a 2" diameter push button so that it can be activated by a person with disabilities.

The center of the button shall be installed at a height of 42" **from the landing area the pedestrian would occupy during activation.** This is important to mention since sometimes the base of the pedestrian pole is higher than the landing area.

The button must also be placed so that the lateral reach does not exceed 10".

Access to Existing Pedestrian Push Buttons



Existing facilities must be accessible by everyone.

Option 1 – Determine there is pedestrian need – provide access

Option 2 – Determine there is not pedestrian need – remove facilities w/ coordination with municipality



Access to pedestrian facilities.

As per ADA, facilities shall not deny access. In the following pictures, paved surfaces and detectable warning surfaces have been added to provide access to the pedestrian push buttons. Since many facilities have been installed without performing a pedestrian study and installed without access, these facilities must be addressed as part of PennDOT's Accessibility Program.

Since existing facilities must be accessible by everyone:

Step 1

Determine if there are pedestrian needs.

Step 2

If there are pedestrian needs – provide access.

If there are no pedestrian needs – remove facilities w/ coordination with municipality

DWS on Shoulders (rare occasions only)

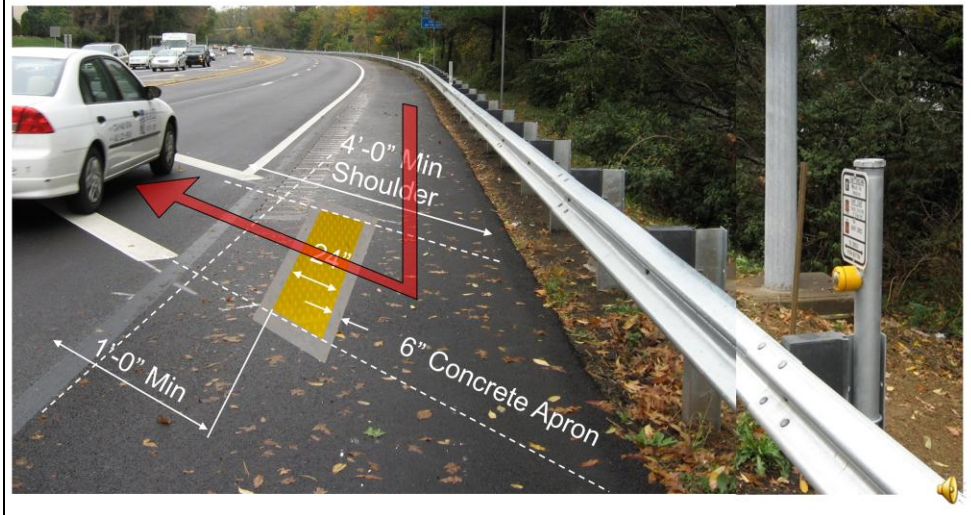

For **very** rare occasions where the shoulder was constructed and designated as a pedestrian access route, truncated domes must be installed to provide access for pedestrians with visual disabilities.

Again this is for very rare occasions where pedestrians are using the shoulder as a pedestrian access route.